

seeglass max<sup>®</sup>

seeglass one<sup>®</sup>

seeglass eco<sup>®</sup>



Create usable spaces  
with unlimited views...



## Seeglass, glass enclosure with no vertical profiles

The glass enclosures with no vertical profiles **seeglass**, have been designed with the purpose of allowing you to enjoy your space all year round..

They are modern and minimalistic systems composed of tempered glass (6, 8, 10 and 12mm options are available), upper and lower profiles. The combination of these components and the absence of vertical profiles will allow you to enjoy your terrace all year round:

### COMPLETELY CLOSED SYSTEM



When the system is closed, it protects your terrace from severe weather conditions.

When opened, it allows you to enjoy the outside weather, like in sunny days.

**Operation:** In order to open the glass enclosure Seeglass, the first glass panel should be opened to the inside or the outside and the following panels will be able to slide in the opening direction. After this, they will fold together with the opening panel. Push or pull each panel, using the glass' edge, and move them as desired. This system embraces a very comfortable way of creating useable spaces.

### HALF-OPENED SYSTEM



### COMPLETELY OPENED SYSTEM



### STACKED PANELS



## DIFFERENT CONFIGURATIONS



### CONFIGURATION EXAMPLES

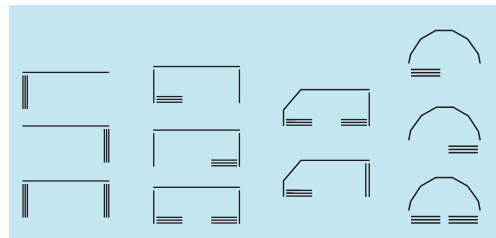

**Seeglass** systems let you slide glass panels in any way desired, being able to adjust to almost any possible configuration. Openings can be internal or external, and have opening devices on the inside or outside. Additionally, all the panels can be easily cleaned.

## PANEL STACKING AND CORNER TURNING

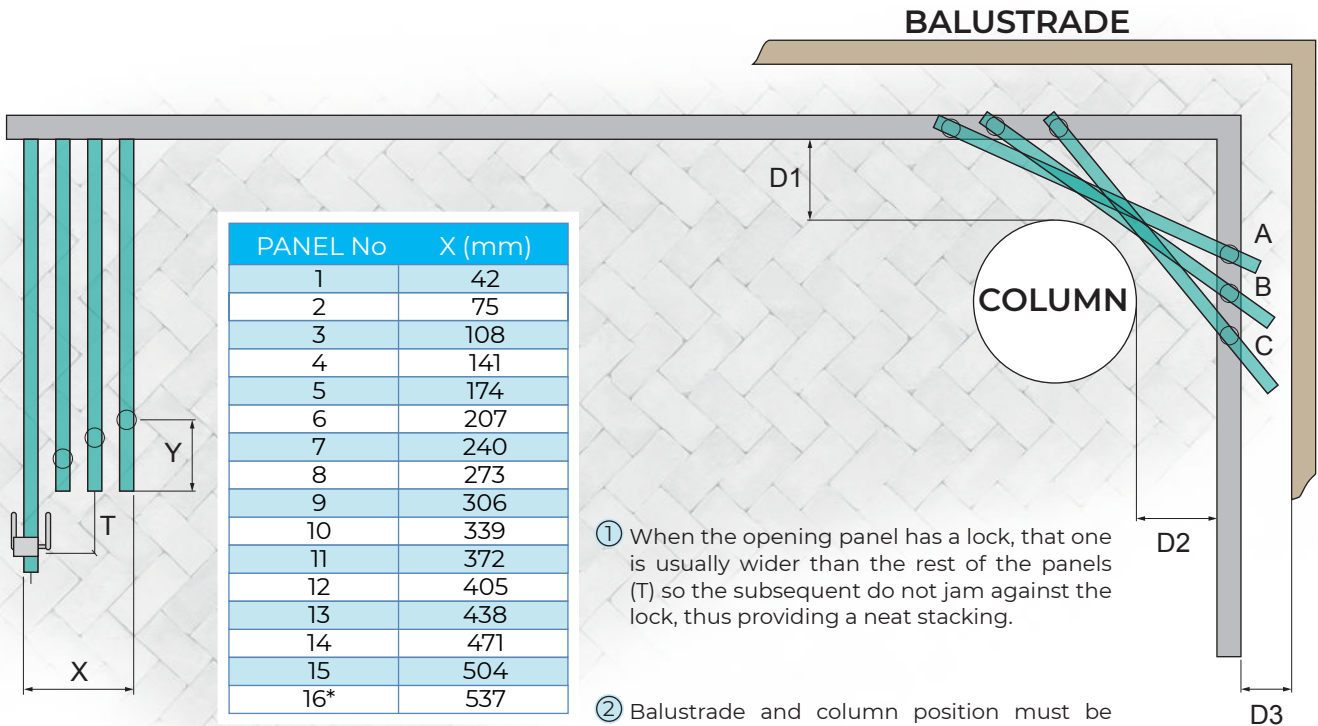

① When the opening panel has a lock, that one is usually wider than the rest of the panels (T) so the subsequent do not jam against the lock, thus providing a neat stacking.

② Balustrade and column position must be taken into consideration when panels turn corners. The diminishing gap between hinges (Y) must also be taken into account as panels are added. The distance to the balustrade or column (D1, D2, D3) must be determined to allow clearance when opening.

\*Maximum recommended number of glass panels depending on their height/width the type of material they are installed on. For a higher amount of panels, please consult with our technical department.



**Seeglass-max** is a sliding and turning glazing system for those who seek an enclosure whose design does not disrupt the aesthetics of the building, and for those who need a higher resistance and sealing under the most adverse weather conditions.

Reinforced steel bearings, anodised aluminium chassis hinges, as well as upper frames and reinforced hinge location sockets give an unmatched robustness to decrease the slightest possibility of breakage or deformation of its components, as a result of improper installation, and/or to an intensive or inadequate use of the system.

Innovative cover design, and 10mm and 12mm tempered glass, make **seeglass-max** the best watertight glass enclosure with no vertical profiles, and the most available system prepared to withstand severe weather conditions.

**Seeglass-max** is placed on the top of the seeglass range, strengthening our brand as a reference in terms of design and innovation in the sector of sliding and folding systems with no vertical profiles.

## TECHNICAL DETAILS · PATENTED SYSTEMS

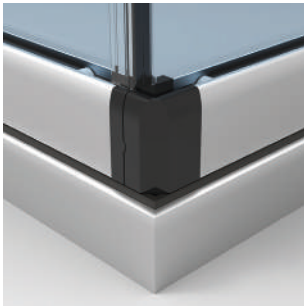

### OVERLAPPED COVER DESIGNED FOR 90°

Overlapped covers designed for systems with 90° shape, which allow a maximum sealing.



### INTEGRATED METALLIC OPENING SYSTEM

This new metallic and symmetrical cap allows a total integration of the opening device into the profiles.

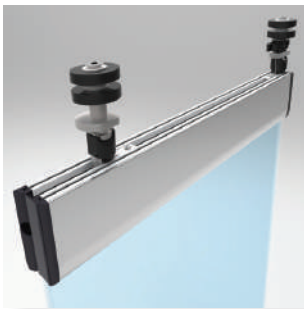

### HINGES AND HIGH RESISTANCE BEARINGS

New aluminium stamped hinges and reinforced bearings in Zamak to reduce possible breakage or deformation of components.



### GLASS FIXING

Glass fixation to the profiles by using screws guarantees a perfect and long-lasting operation, as well as guaranteed safety. The fixing is completed by using adhesive polymer as an extra added for security reasons.

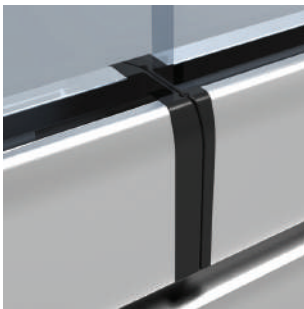

### PANEL COVERS

New panel overlapping cover design provides an optimised seal, thus preventing air and water from entering inside the glass enclosure.



### LOWER EMBEDDED PROFILE

Lower embedded profile for installation at ground level as an option when needed for a complete access.

## SYSTEM SECTIONS

No upper telescopic profile  
Lower standard profile

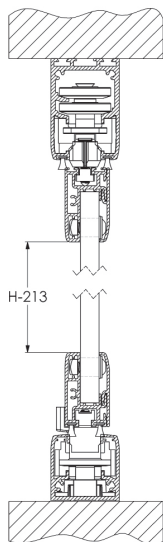

No upper telescopic profile  
Lower embedded profile

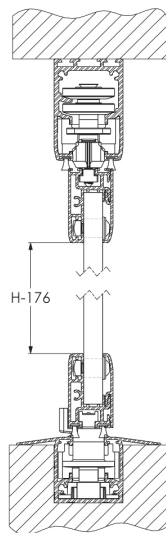

Upper telescopic profile  
Lower standard profile

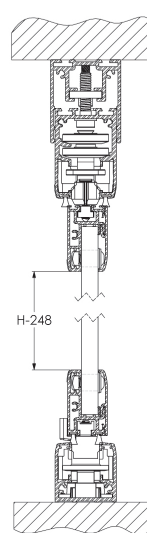

Upper telescopic profile  
Lower embedded profile

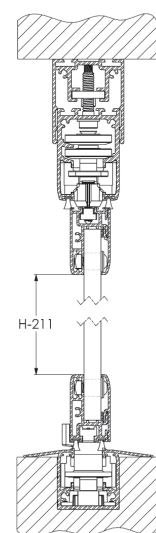



**Seeglass-one** is a high quality glazing system designed to create comfortable living spaces and increasing your property value.

These sliding and folding glazing systems are adaptable to a variety of different environments including winter gardens, balconies, terraces and even shopping areas. They are technologically advanced systems that are easily installed to create new usable spaces, Furthermore, they protect from severe weather conditions when closed.

In short, **seeglass-one** is perfect solution for hotels, restaurants, cafeterias, shops, offices, and inside partitions.

## TECHNICAL DETAILS · PATENTED SYSTEMS

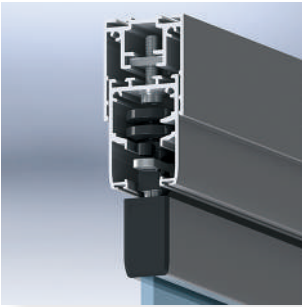

### UPPER TELESCOPIC PROFILE

Thicker upper profile, with reinforcement in the brackets to avoid deformation due to weight.



### INTEGRATED METALIC OPENING SYSTEM

This new symmetrical metallic cap allows a total integration of the opening device into the profiles.

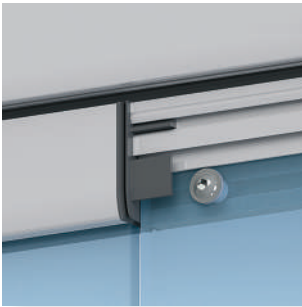

### GLASS FIXING

Glass fixing to the profiles by using screws guarantees a perfect and long-lasting operation, as well as guaranteed safety. The fixing is completed by using adhesive polymer as an extra security layer.

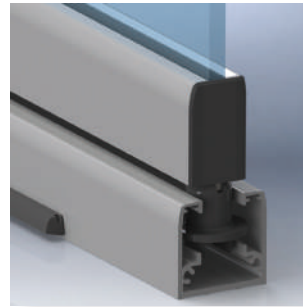

### LOWER STANDARD PROFILE

Lower standard profile for installation above the ground level. suelo.



### LOWER EMBEDDED PROFILE

Lower embedded profile for installations that want to avoid the step and need it to be at ground level.

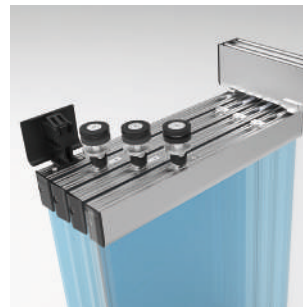

### OPERATION

A highly resistant hinges and bearings system, specially designed for continuous usage. The sliding of the panels is smooth and silent.

## SYSTEM SECTIONS

No upper telescopic profile  
Lower embedded profile

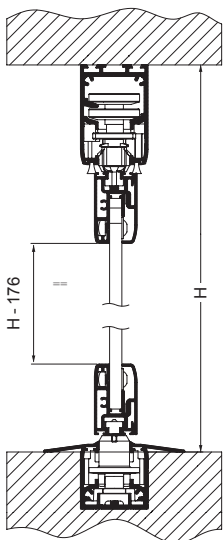

No upper telescopic profile  
Lower standard profile

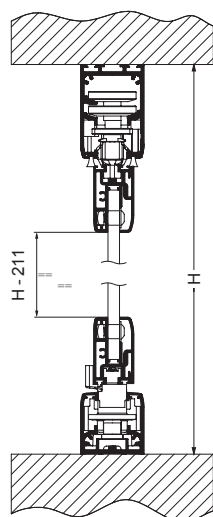

Upper telescopic profile  
Lower embedded profile

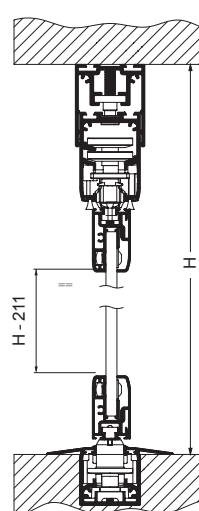

Upper telescopic profile  
Lower standard profile

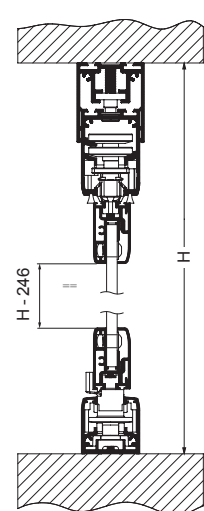



**Seeglass-eco, state-of-the-art system developed and manufactured fully by C3 Systems**

This system increases your property living space, allowing the employment of spaces that may be underused due to their location or conditions. With the installation of this glazing enclosure, you can create a comfortable living space to be enjoyed all year long, like a children playground, studio, or just a protected and clean terrace. In addition, all the panels can be easily cleaned from the inside, thus avoiding nuisances such as wind, noise and dirt.



## TECHNICAL DETAILS · PATENTED SYSTEMS

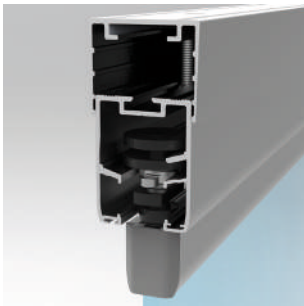

### UPPER TELESCOPIC PROFILE

The upper telescopic profile absorbs building irregularities up to 20mm of height.

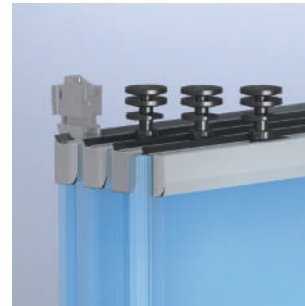

### TOP QUALITY ACCESSORIES

Enclosure system and bearing components are made of high quality and resistant materials, technically designed plastic parts, stainless steel screws, etc.



### INTERMEDIATE OPENING

The panels may be opened partially, as the first panel can be locked into the support and the rest are able to be slightly moved to permit a controlled ventilation.



### DRILLED GLASS/FIXED BY SCREWS

The glass is guaranteed to be completely fixed to the profiles by using screws, which allows a perfect and long-lasting operation.

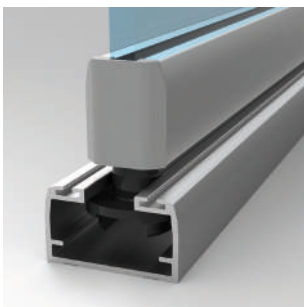

### LOWER STANDARD PROFILE

The 23 mm minimalistic lower profile allows a clear view.



### LOWER LATCH COVER

This new lower latch design perfectly covers the panel exit when the system remains closed, thus increasing the efficiency of the system.

## SYSTEM SECTIONS

Upper telescopic profile  
Lower standard profile

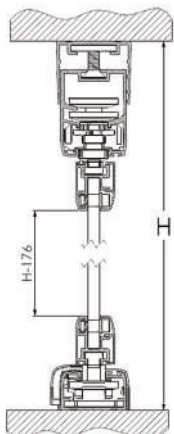

No upper telescopic profile  
Lower standard profile

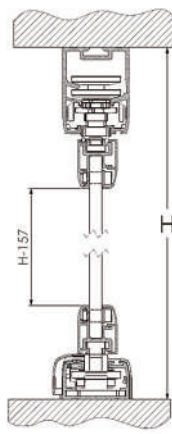

## MINIMALIST DESIGN

Seeglass-eco has a minimalistic design, with much thinner profiles, allowing a limitless view.

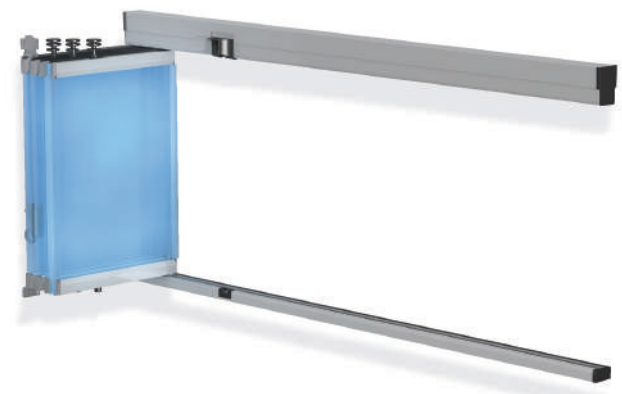

## CONTINUOUSLY USED DOOR MAIN DOOR



max one eco



**C3 Systems** presents the new continuously used door "MAIN DOOR", specially designed for public spaces, like restaurants, shops, offices, etc, where the door is being used constantly.

## AUXILIARY CONDENSATION PROFILE

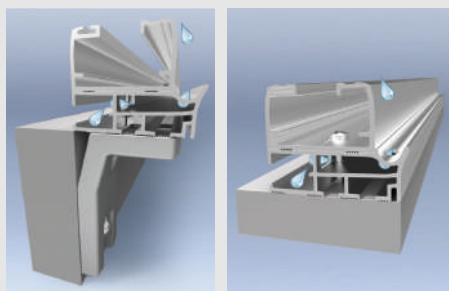

This new auxiliary condensation profile is specially designed to drain out the water that forms due to temperature changes. It can be installed with or without bracket support.

max one eco

## LATERAL PROFILES

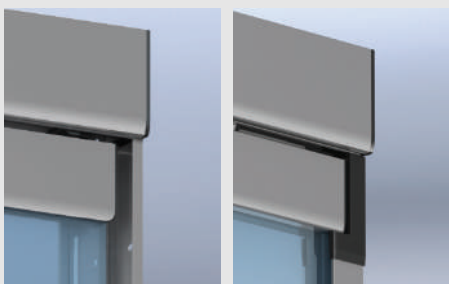

Lateral profiles are specially designed for preventing the entrance of air. It is also used for adding extra stability to the panels as well as a compensator in cases where there are imperfections on the sides. Fast and easy installation, and it can be easily added to a previously installed system.

max one eco

## BRACKET SUPPORT

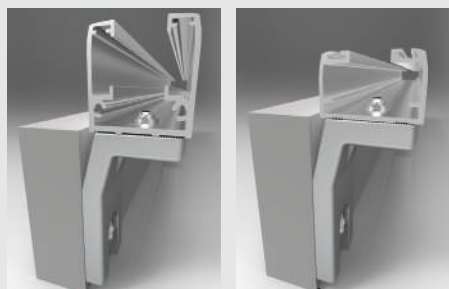

This new bracket support will allow you to install the lower profiles in those systems that cannot be installed on a wall or a balustrade.

max one eco

# Available options

## MOVING DOOR

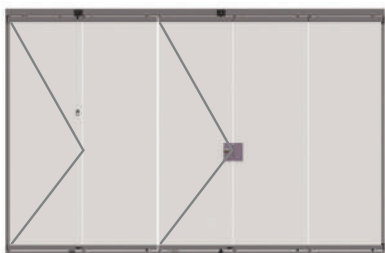

The Moving Door can be placed in any part of the **Seeglass** system and it can be opened and closed according to the client's needs without having to open the entire system.

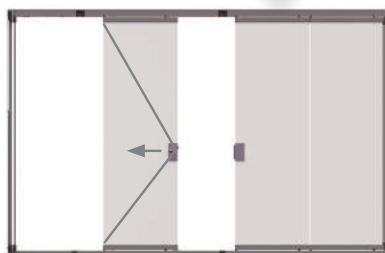

The moving door functions as another panel which slides and folds to the side when the system is open.

**max** **one** **eco**

Maximum Height: 2.500 mm  
Maximum panel width: 750 mm

Only available for the **seeglass-max** system.

New

## NEW UPPER PROFILE FOR ROLLER BLIND



**max** **one** **eco**

The new upper telescopic profile has been especially designed for supporting roller blinds on top of the system without adding any auxiliary profile.

Maximum width of the bracket to install: 80 mm

## NEW HANDRAIL PROFILE



**seeglass pro**

With a new handrail profile for our balustrade **Seeglass Pro**, the other three **Seeglass** systems will be able to be installed on top of it, increasing the view and the brightness.

**max** **one** **eco**

## PANEL BLOCKING KIT

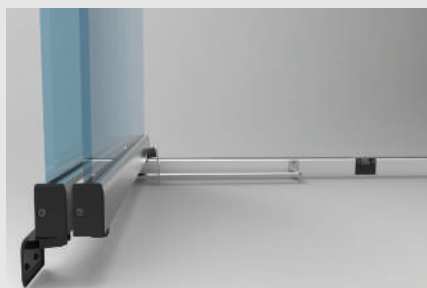

This new panel blocking kit allows a firm and elegant grip of the panels once the system is opened.

**max** **one** **eco**

# Available options

## ROD AND CABLE OPENING DEVICES



Our standard opening device uses a rod, but if you wish to add a different and more elegant touch to your **Seeglass** system, now you can choose a metallic cable option as well. With a minimalistic and very elegant design, this cable opening device allows you an even wider view.

max one eco

## SIMPLE AND DOUBLE KNOBS



Elegant and minimalistic, this opening device is another option which can be chosen for your **Seeglass** system.

max one eco

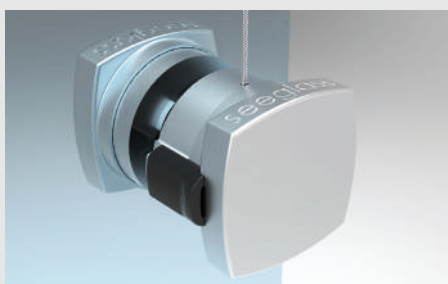

The main difference from other systems is the possibility to easily adjust the cable tension produced by continuous usage, so it doesn't lose its functionality. Two different models can be chosen: simple knob and double knob, which allows the opening from inside and outside.

## LOWER LOCK FOR SIMPLE AND DOUBLE KNOB

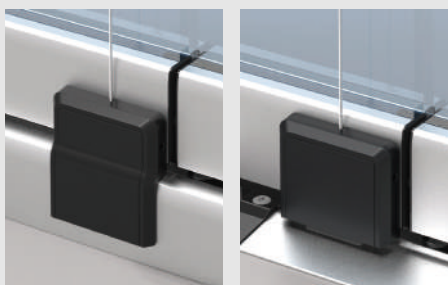

This device acts as a second locking point on the opening panel. It is the standard option on all **Seeglass** knobs. Not compatible with **Seeglass Eco**.

max one eco

## CRANK AND KNOB LOCKS



**Seeglass** offers the possibility of adding security key locks to the systems.

max one eco

## TECHNICAL SPECIFICATIONS

CONTENT TABLE

	MAX		ONE		ECO	
	10 mm glass	12 mm glass	8 mm glass	10 mm glass	6 mm glass	8 mm glass
Weight	29 kg / m <sup>2</sup>	34 kg / m <sup>2</sup>	23 kg / m <sup>2</sup>	28 kg / m <sup>2</sup>	17 kg / m <sup>2</sup>	22 kg / m <sup>2</sup>
Maximum height	3000 mm		2500 mm	3000 mm	1700 mm	2000 mm
Maximum system width	Unlimited		Unlimited		Unlimited	
Maximum panel width	800 mm		800 mm		800 mm	
Type of glass	Tempered		Tempered		Tempered	
Glass fixing	Screwed and stuck		Screwed and stuck		Screwed and stuck	
Intermediate opening	Yes		Yes		Integrated	
Exterior opening	Yes		Yes		Yes	
Moving door	Yes		No		Yes	
Lower embedded profile	Yes		Yes		Yes	
Available finishes	Anodised, RAL colours and wood effect					

## WIDTH-HEIGHT TABLE / SYSTEMS' WEIGHT

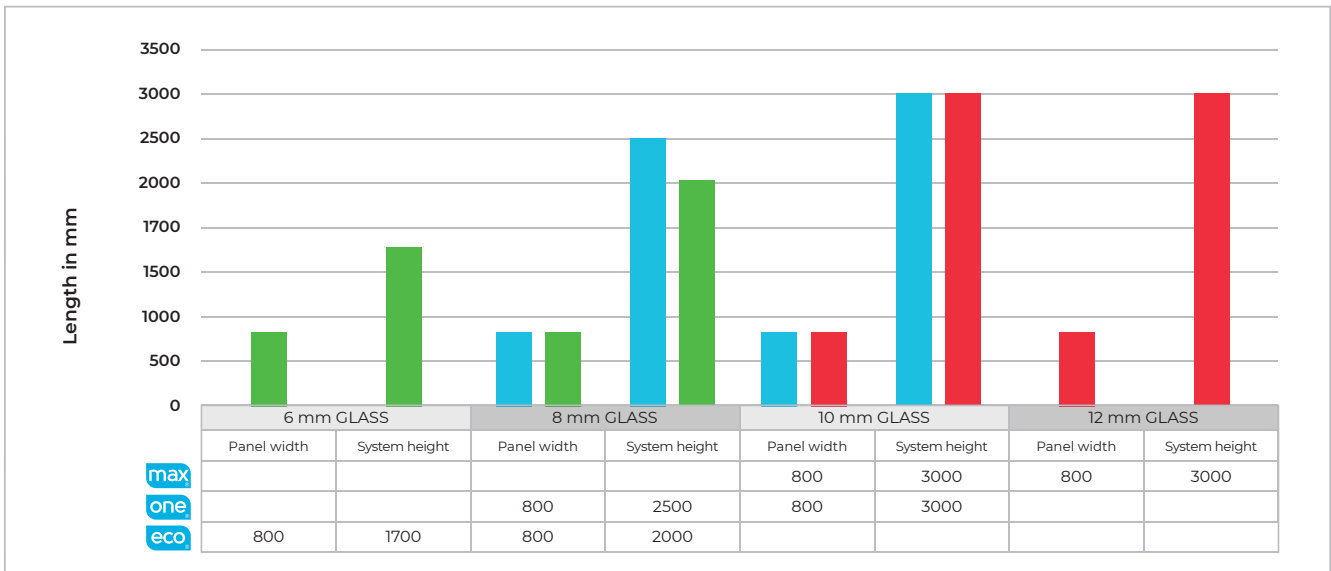

max	one	eco
12 mm glass 34 kg/m <sup>2</sup>	8 mm glass 23 kg/m <sup>2</sup>	6 mm glass 17 kg/m <sup>2</sup>
10 mm glass 29 kg/m <sup>2</sup>	10 mm glass 28 kg/m <sup>2</sup>	8 mm glass 22 kg/m <sup>2</sup>

## MAXIMUM EVENLY DISTRIBUTED LOAD SUPPORTED

Panel size:  
800 x 1900 mm

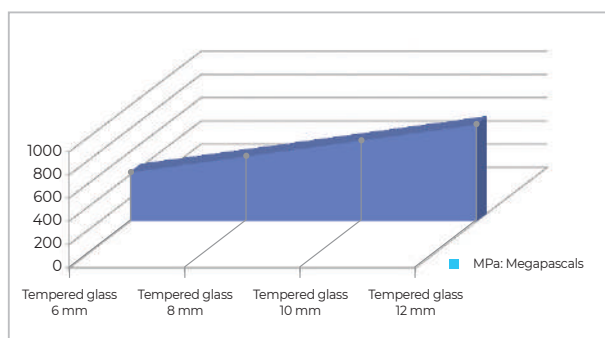

## ROLLER BLIND

habitat sun®



Adaptive comfort for solar protection.

The **habitat-sun** roller blinds are modern solar protection systems created to meet the most varied demands. They offer solutions for most types of glass curtain, since it adapts to the top thanks to its expander profile without impeding the functionality of the system. In addition, they contribute to significantly optimize the energy efficiency of the space, allowing a better use of solar energy. **They are available with both manual and motorised mechanisms.** You can create an environment tailored to the decoration of your home thanks to its wide range of fabrics and finishes.

## PLEATED BLINDS

habitat sun®



The lightest and the most efficient sun protection.

The pleated **habitat-sun** model is a very light fabric blind; easy to handle. It fits perfectly to minimum rolling spaces and contributes significantly to the optimisation of the space efficiency, allowing a better use of solar energy. It offers a variety of positions according to protection needs at any time of the day. **It can be folded from the bottom up, top down or left in the middle as a tool for creativity and style in your space.** You can create an environment in accordance with your home decor thanks to its wide range of basic, micro-perforated and black-out colours.

## PLEATED MOSQUITO NET

habitat net®

Customise your environment and enjoy better comfort.

**Habitat-net** is a pleated mosquito net system specially designed by C3 Systems to cover big dimensions without sacrificing resistance, functionality, aesthetics and design.

**It has achieved an important European certification (European Class 2) of wind resistance, an improvement in the thermal transmittance (-0.56 W/m· K), and a reduction of background noise (1db).**

The net also got the maximum classification in water, salinity and sunlight resistance tests.



## CERTIFICATES

All our systems and their components are designed by **C3 Systems, S.L.** engineers and manufactured in Spain, so you will be purchasing a product of excellent quality. Due to having passed the most strict quality controls, there are product certificates available for the **Seeglass** range of products. You will be able to check the values for wind resistance, water tightness, etc.

**Seeglass** is the best glass enclosure with no vertical profiles available at the market, which allows us to offer a **guarantee up to 15 years.\***

\*(To read the guarantee in detail, please download the general sales conditions on the website's customer area).

**Seeglass** is produced and manufactured in **SPAIN** and all the components have been designed by our team of engineers and manufactured under a strict quality control.

**Seeglass** has a **CE mark**. We identify, test, and certify our products' authenticity with a Declaration of Conformity properly stamped and signed.

### GLASS GUARANTEE

**Seeglass** has all the necessary official documents that certify the quality of the glass available to clients. We use high resistant tempered, secure, and polished edges glass. We are sure you and your family will enjoy a **safe and guaranteed product**.

**Seeglass** aluminium is processed according to the International Standards of **Qualanod**, **Qualideco** and **Qualicoat**, which certifies the quality of processing.

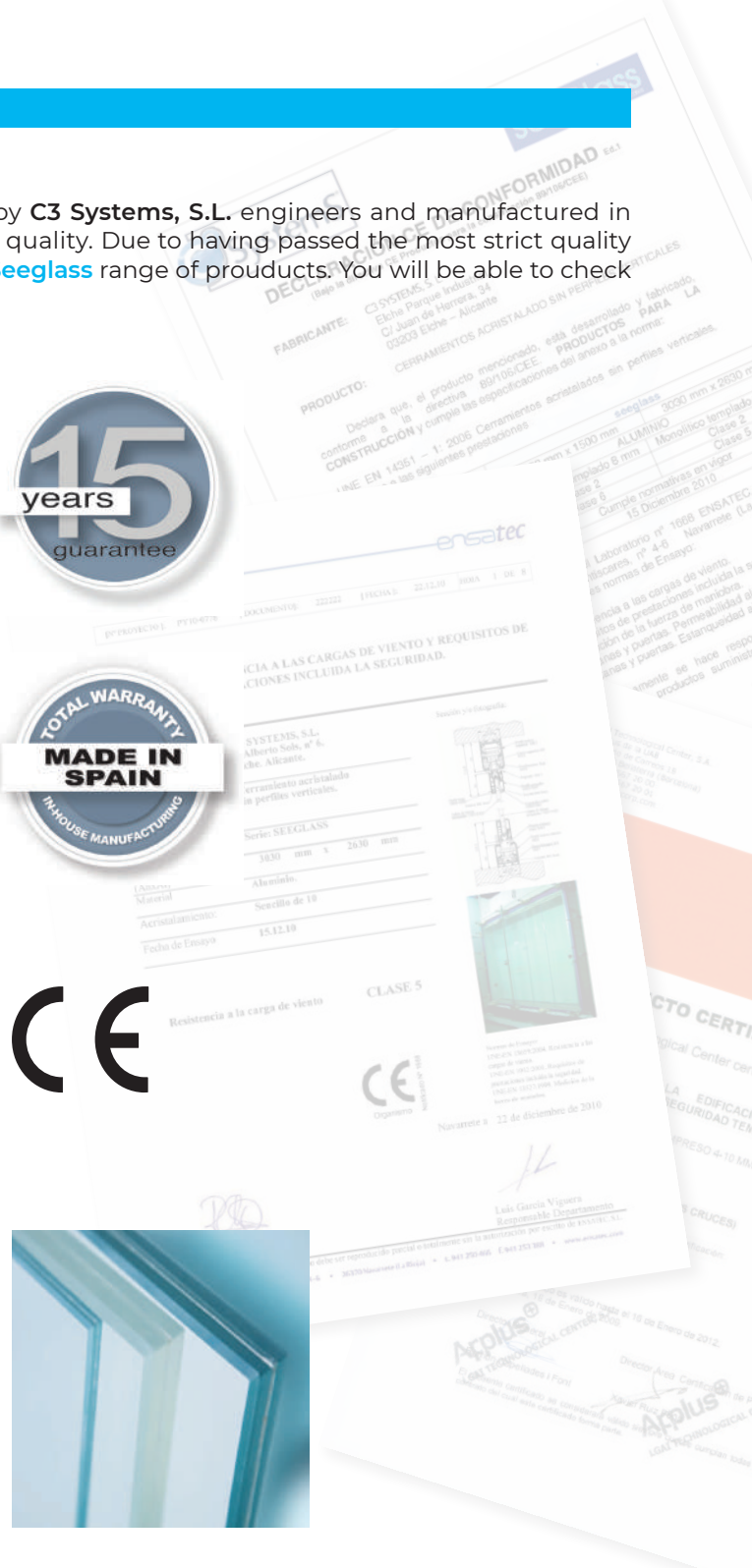



**MADE IN SPAIN**



C3 Systems, S.L. · Juan de Herrera, 39 · Elche Parque Empresarial · 03203 Elche (Alicante) España · Telf. +34 966 286 186 · Fax: +34 965 682 677  
c3systems@c3systems.es · www.c3systems.es · www.seeglass.es



The purpose of this document is to meet a commercial function. It does not constitute an authentic advertising offer in a "strict" sense. If you would like to formalise a contract, please contact C3 Systems, SL in order to offer you specific and personalised information that contains objective information regarding relevant characteristics. This means it will constitute an offer in a "strict" sense.

C3 Systems S.L. commits not to make misleading advertising by this means. To these effects, therefore, formal or numerical errors that could be found in the content of this document are not considered as misleading advertising, in particular regarding to the images accompanying in an illustrative way, and not contractual. In any case C3 Systems SL commits to correct it as soon as it becomes aware of such errors.