

EVO

EV 835E10N

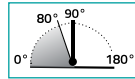

EVO

EV 835E11N

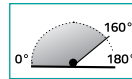

MAX 120 Kg - 264 lbs

Porte - Doors

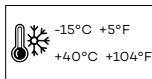
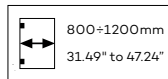
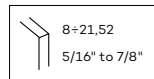

• Cerniera oleodinamica vetro-muro per porte in battuta, con velocità di chiusura regolabile e controllo costante di frenatura; permette un'apertura della porta fino a 180°. Si installa su porte con profilo in battuta. Profondità stipite da 30 a 50 mm.

• Hydraulic hinge glass to wall for doors with stop, with adjustable closing speed and constant braking control; the door opens up to 180°. Installed on doors with a profile on a stop. Jamb depth from 30 to 50 mm.

EV 835E10N R = destra - right

EV 835E10N L = sinistra - left

EV 835E11N R = destra - right

EV 835E11N L = sinistra - left



Alluminio / Aluminium : 02-05-13-14-15-16-17-RAL-62-88-95



Per installazioni in condizioni ambientali e climatiche particolari (es. Umide, acide, saline), consultare prima l'ufficio commerciale

For installations in particular environments or climate (ex. Wet, acid, saline) consult sales office first



È necessaria una battuta in chiusura in quanto la cerniera ha una precarica.

The hinge is preloaded which makes an end stop necessary.

Classificazione secondo normativa - Clasificación según la ley - Classification according to inf1 regulation Klassifizierung nach den Vorschriften - Classification selon la norme				
	UNI EN 1154 : 2006	3	8	$\frac{3}{6}$
0	1	4		

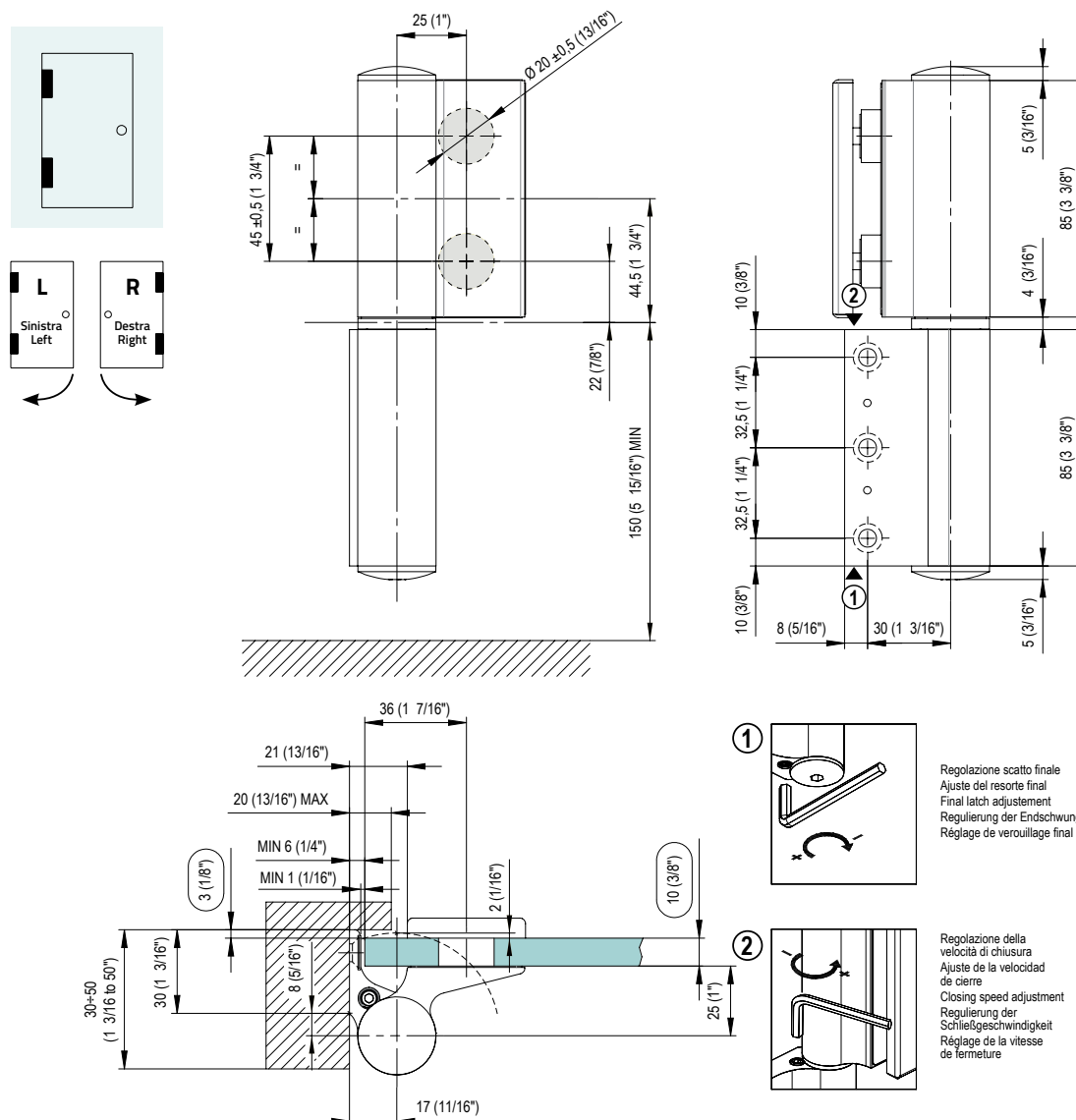

EV 835E10N SOL EVO FREE HINGE

 **100 Kg - 220 lbs**

 **Porte - Doors**

EVO
oleodinamiche

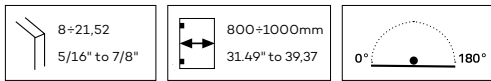

• Cerniera libera vetro-muro per porte in battuta. Da abbinare con EV835E10N-EV835E11N. Si installa su porte con profilo in battuta. Profondità stipite da 30 a 50 mm.

• Free hinge wall-glass for doors with stop. To be matched with EV835E10N-EV835E11N. Installed on doors with a profile on a stop. Jamb depth from 30 to 50 mm.

EV 835E10NSOL R = destra - right

EV 835E10NSOL L = sinistra - left



Alluminio / Aluminium : 02-05-13-14-15-16-17-RAL-62-88-95

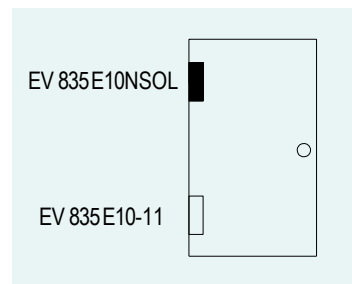
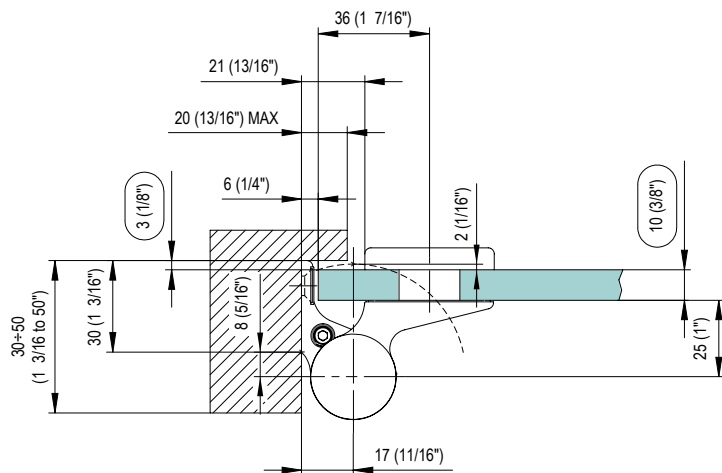
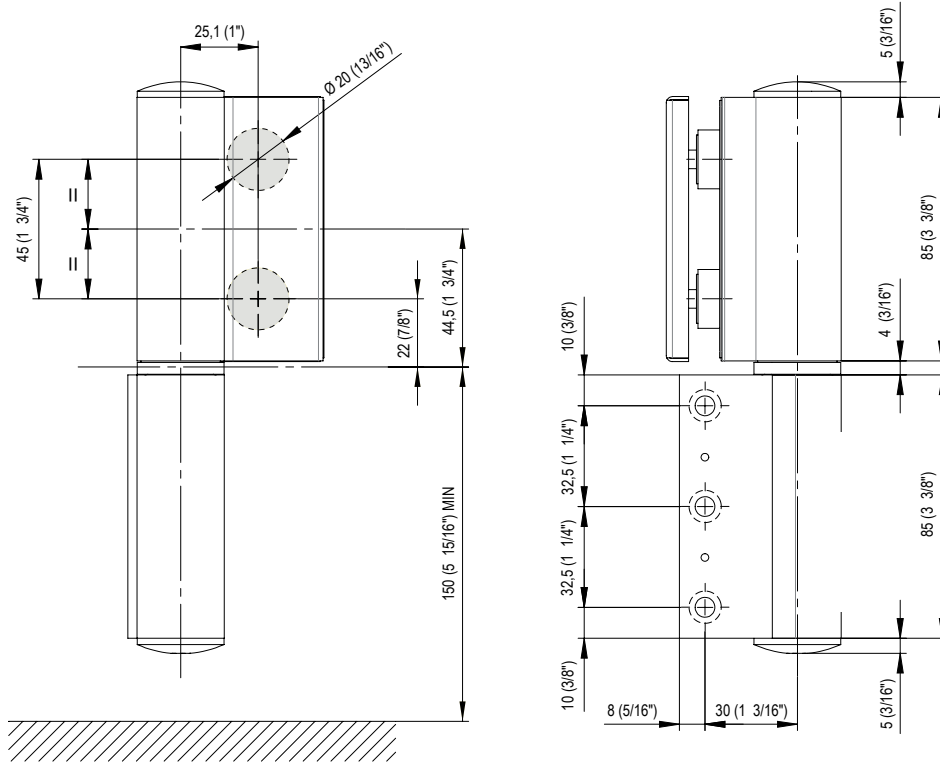
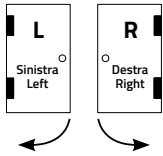

EVO

EV 835E50N

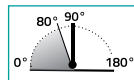

EVO

EV 835E51

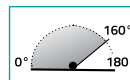

MAX 100 Kg - 220 lbs → Porte - Doors

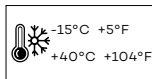
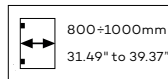
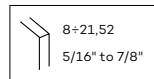

• Cerniera oleodinamica vetro-vetro per porte in battuta, con velocità di chiusura regolabile e controllo costante di frenatura; permette un'apertura della porta fino a 180°. Si installa su porte con profilo in battuta. Profondità stipite da 30 a 50 mm.

• Hydraulic hinge glass to glass for doors with stop, with adjustable closing speed and constant braking control; the door opens up to 180°. Installed on doors with a profile on a stop. Jamb depth from 30 to 50 mm.

EV 835E50 R = destra - right

EV 835E50 L = sinistra - left

EV 835E51 R = destra - right

EV 835E51 L = sinistra - left



Alluminio / Aluminium : 02-05-13-14-15-16-17-RAL-62-88-95



Per installazioni in condizioni ambientali e climatiche particolari (es. Umide, acide, saline), consultare prima l'ufficio commerciale

For installations in particular environments or climate (ex. Wet, acid, saline) consult sales office first



È necessaria una battuta in chiusura in quanto la cerniera ha una precarica.

The hinge is preloaded which makes an end stop necessary.

Classificazione secondo normativa - Clasificación según la ley - Classification according to int'l regulation - Klassifizierung nach den Vorschriften - Classification selon la norme				
UNI EN 1154 : 2006	3	8	3/6	0 1 4

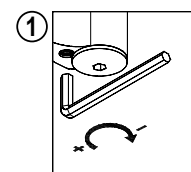
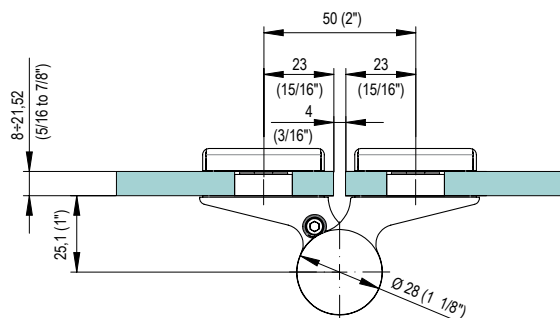
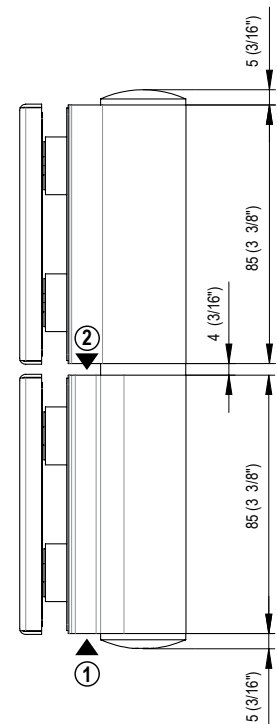
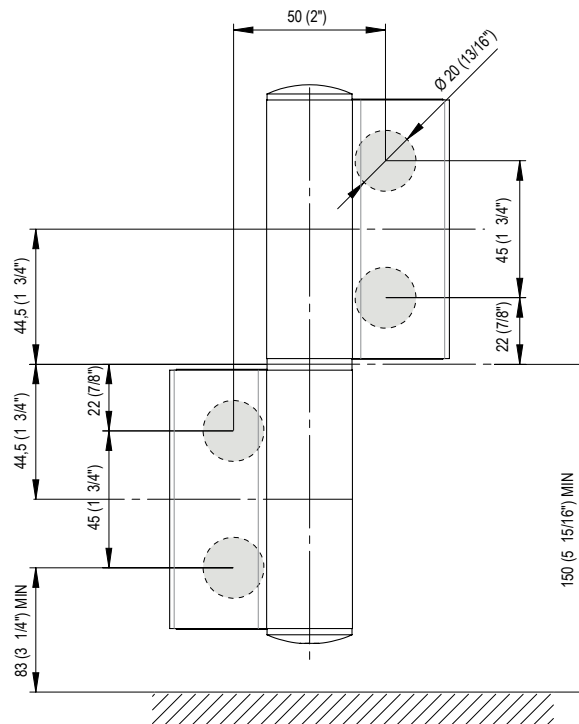
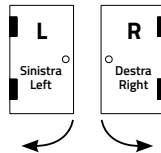
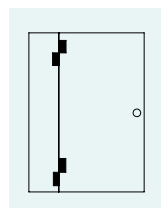

Regolazione scatto finale
Ajuste del resorte final
Final latch adjustment
Regulierung der Endschloßung
Réglage de verrouillage final

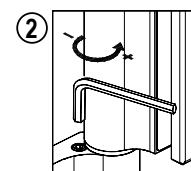

Regolazione della velocità di chiusura
Ajuste de la velocidad de cierre
Closing speed adjustment
Regulierung der Schließgeschwindigkeit
Réglage de la vitesse de fermeture

EV 835E50 SOL EVO FREE HINGE

 **100 Kg - 220 lbs**

 **Porte - Doors**

EVO
oleodinamiche

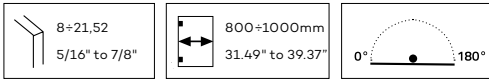

• Cerniera libera vetro-vetro per porte in battuta.
Da abbinare con EV 835E50-EV 835E51.

• Free hinge glass-glass for doors with stop.
To be matched with EV 835E50-EV 835E51.

EV 835E50SOL R = destra - right

EV 835E50SOL L = sinistra - left



Alluminio / Aluminium : 02-05-13-14-15-16-17-RAL-62-88-95

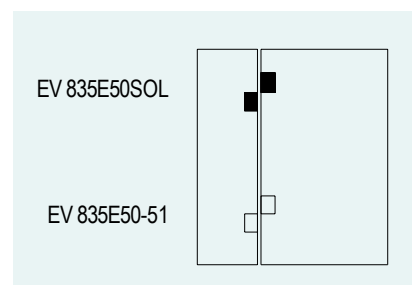
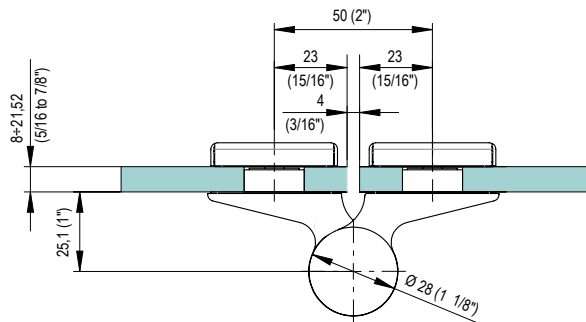
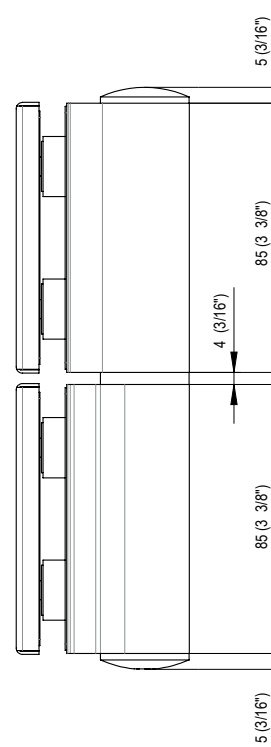
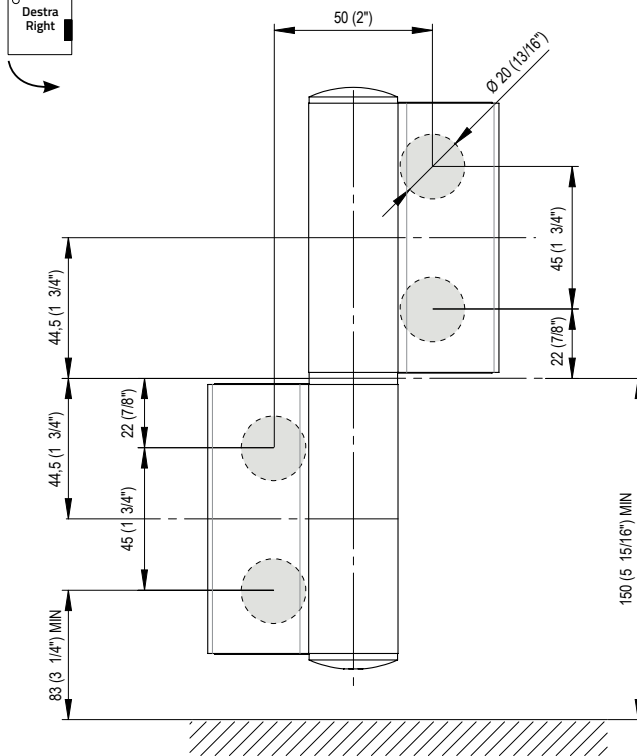
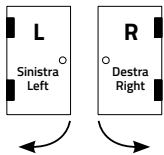

Riepilogo applicazioni disponibili con Biloba EVO. Chiusura automatica da 90° e 180°

Biloba EVO applications summary. Automatic closing from 90° and 180°

SOLUZIONE - SOLUTION 1

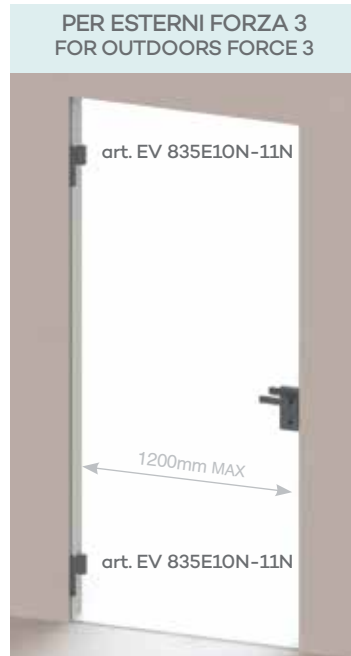

SOLUZIONE - SOLUTION 2

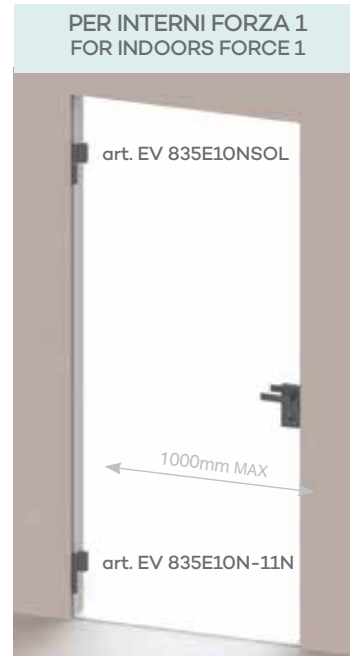

- 2 cerniere EVO nella versione standard
- Disponibile nelle versioni vetro-muro art.EV 835E10N e vetro-vetro art.EV 835E50
- Per porte fino a 120 kg
- Anta da 800mm a 1200 mm
- Sp. vetro 8-21.52 mm
- Per esterni
- Forza 3

- 2 bisagras EVO versión standard
- Disponible en las versiones pared-vidrio art.EV 835E10N y vidrio-vidrio art.EV 835E50
- Para puertas hasta 120 kg
- Ancho de puerta de 800mm a 1200 mm
- Espesor de vidrio 8-21.52 mm
- Para exteriores
- Fuerza 3

- 2 EVO hinges in the standard version
- Available glass-to-wall, item EV 835E10N and glass-to-glass item EV 835E50
- For doors up to 120 kg
- Door width from 800 mm to 1200 mm
- Glass thickness 8 - 21.52 mm
- For outdoors
- Force 3

- 2 Hydraulikbänder EVO Standard Version
- Verfügbar in der Ausführung Glas-Wand Art.EV 835E10N und Glas-Glas Art.EV 835E50
- Für Glastüren bis 120 kg
- Türbreite von 800mm bis 1200 mm
- Glasdicke 8-21.52 mm
- Für Außen
- Stärke 3

- 2 charnières EVO dans la version standard
- Disponible dans les versions verre-art.EV 835E10N et verre-verre art.EV 835E50
- Pour portes jusqu'à 120 kg
- Battant de 800mm à 1200 mm
- Ép. vitre 8-21.52 mm
- Pour extérieur
- Force 3

- 1 cerniera EVO standard 1 cerniera Evo Libera
- Disponibile nelle versioni vetro-muro art.EV 835E10NSOL e vetro-vetro art.EV 835E50SOL
- Per porte fino a 100 kg
- Anta da 600mm a 1000 mm
- Sp. vetro 8-21.52 mm
- Per interni
- Forza 1

- 1 bisagra EVO standard 1 bisagra Evo Libre
- Disponible en las versiones pared-vidrio art. EV 835E10NSOL y vidrio-vidrio art.EV 835E50SOL
- Para puertas hasta 100 kg
- Ancho de puerta de 600mm a 1000 mm
- Espesor de vidrio 8-21.52 mm
- Para interiores
- Fuerza 1

- 1 standard EVO + 1 free Evo
- Available glass-to-wall, item EV 835E10NSOL and glass-to-glass item EV 835E50SOL
- For doors up to 100 kg
- Door width from 600 mm to 1000 mm
- Glass thickness 8 - 21.52 mm
- For indoors
- Force 1

- 1 Hydraulikband EVO Standard 1 Hydraulikband Evo mit Freilauf
- Verfügbar in den Ausführungen Glas-Wand Art.EV 835E10NSOL und Glas-Glas Art.EV 835E50SOL
- Für Glastüren bis 100 kg
- Türbreite von 600mm bis 1000 mm
- Glasdicke 8-21.52 mm
- Für Innenräume
- Stärke 1

- 1 charnière EVO standard et 1 charnière Evo Libre
- Disponible dans les versions verre-mur art. EV 835E10NSOL et verre-verre art.EV 835E50SOL
- Pour portes jusqu'à 100 kg
- Battant de 600mm à 1000 mm
- Ép. verre 8-21.52 mm
- Pour intérieur
- Force 1

EV 835E40 EVO



MAX 120 Kg - 264 lbs

Porte - Doors

30=50mm 1 1/4" to 2"	800=1200mm 31.49" to 47.24"	-15°C +5°F +40°C +104°F	80° 90° 0° 180°
-------------------------	--------------------------------	----------------------------	--------------------

• Cerniera oleodinamica per frame e per porte in battuta, con velocità di chiusura regolabile e controllo costante di frenatura; permette un'apertura della porta fino a 180°. Stop a +90° +180°. Si installa su porte con profilo in battuta. Profondità stipite da 30 a 50 mm.

• Hydraulic hinge for frames, for doors with stop, with adjustable closing speed and constant braking control; the door opens up to 180°. Stop at +90° +180°. Installed on doors with a profile on a stop. Jamb depth from 30 to 50 mm.

EV 835E40 R = destra - right
EV 835E40 L = sinistra - left



Alluminio / Aluminium: 02-05-13

i Solo aper porte in legno - For wooden doors only

Classificazione secondo normativa - Clasificación según la ley - Classification according to int'l regulation Klassifizierung nach den Vorschriften - Classification selon la norme

UNI EN 1154 :2006	3	8	3/6	0	1	4
-------------------	---	---	-----	---	---	---

! È necessaria una battuta in chiusura in quanto la cerniera ha una precarica.
The hinge is preloaded which makes an end stop necessary.

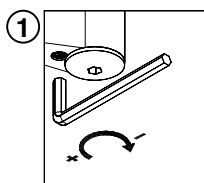
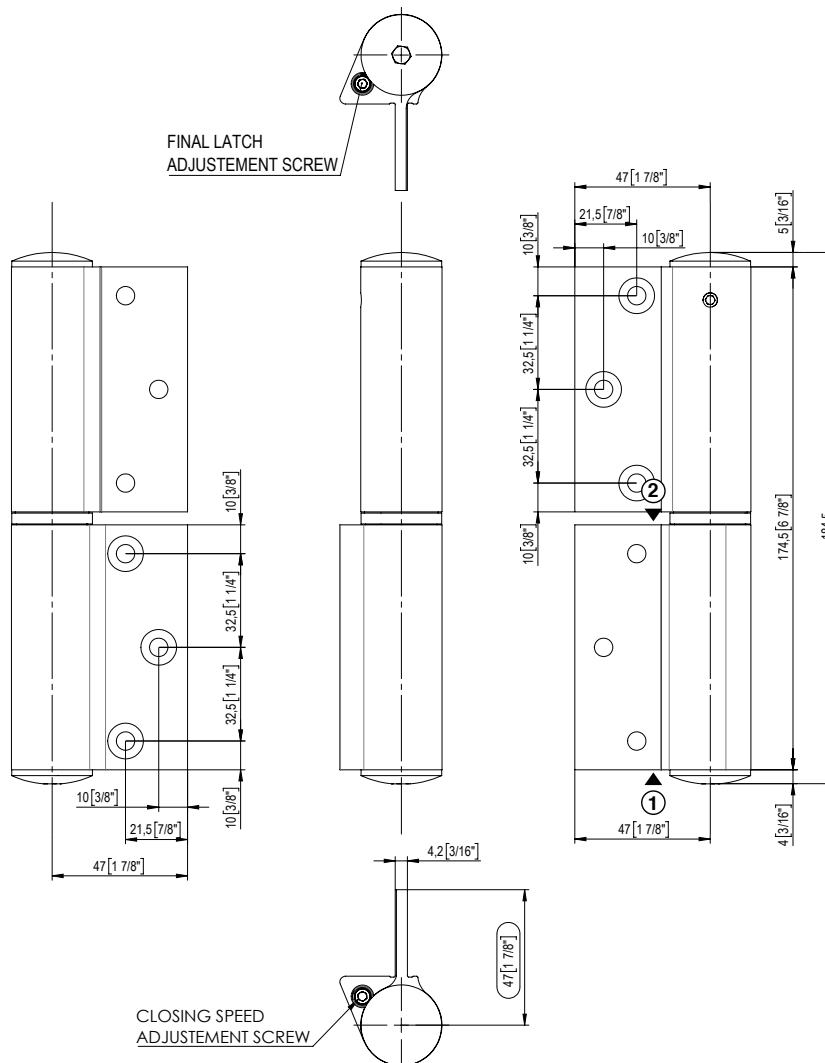
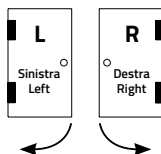
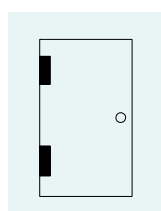

Regolazione scatto finale
Ajuste del resorte final
Final latch adjustment
Regulierung der Endschwung
Réglage de verrouillage final

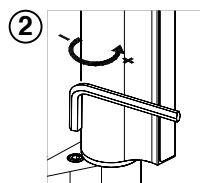

Regolazione della velocità di chiusura
Ajuste de la velocidad de cierre
Closing speed adjustment
Regulierung der Schließgeschwindigkeit
Réglage de la vitesse de fermeture

EV 835E40 SOL EVO FREE HINGE

 **120 Kg - 264 lbs**

 **Porte - Doors**

EVO
oleodinamiche

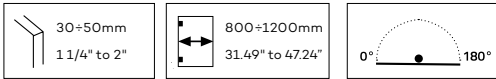

- Cerniera libera per frame e per porte in battuta. Da abbinare con EV 835E40. Si installa su porte con profilo in battuta. Profondità stipite da 30 a 50 mm.
- Free hinge for frames, for doors with stop. To be matched with EV 835E40. Installed on doors with a profile on a stop. Jamb depth from 30 to 50 mm.

EV 835E40SOL R = destra - right
EV 835E40SOL L = sinistra - left

 **Solo aper porte in legno - For wooden doors only**

